

Features and Benefits

- **Extending the Return-on-Investment of Harmony Systems:** New system hardware and software releases increase operating efficiency and extend the life of installed systems. New products and programs make the decision to evolve existing systems straightforward and easy.
- **Achieving an Extended Automation scope with System 800xA:**
 - **Personalized User Workplaces:**
Reduced time to decision and action is achieved with 800xA Process Portal personalized workplaces. Information and workplace layouts are optimized to maintenance, engineering, management, and operating personnel preferences and needs.
 - **Wide-ranging control functionality:**
Applicable for control and safety applications, AC 800M Control and I/O meet all plant automation needs. AC 800M integration with Harmony systems is made easy through the INFI90 Function Code (FC) Library and peer-to-peer communications with Harmony controllers.
 - **Device Management:** Device Management features lower lifecycle costs through significant savings in the design, implementation, and operation of field equipment.
 - **Asset Optimization:** Significantly increase process uptime and reduce maintenance costs through optimized remediation work processes and early detection of asset performance problems.
 - **Information Management:** Improve visibility of integrated information results in effective decision-making.
- **Lowering System Lifecycle Costs and Risk through System Evolution:**
Evolution programs ensure that automation systems are continually optimized to support customer business goals.

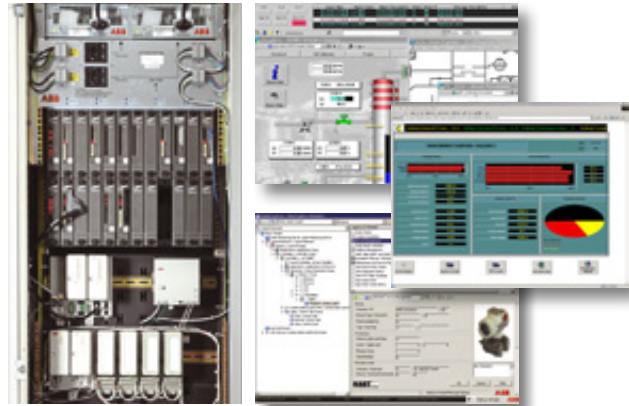

To be successful in today's highly competitive business markets, companies drive their production facilities toward Operational Excellence (OpX) with defined goals of maximizing Return on Net Assets (RONA), lowering Total Cost of Ownership (TCO), sharing best practices throughout the enterprise, and driving profitable, sustainable growth. Achieving these goals require more than what a traditional Distributed Control System (DCS) can offer. It requires a plant automation system that can improve:

- Plant effectiveness – the ability to combine the right decisions with optimized work processes
- Plant agility – the ability to make 'on-the-fly' adjustments as business opportunities present themselves with the same proficiency as when performing the routine
- Performance visualization – the ability to provide users with real-time performance and feedback

In general, OpX can only be achieved by extending the reach of plant automation systems to synchronize all process operations within one common environment for operations, engineering, and information.

ABB delivers this extended automation scope by combining the SYMPHONY Harmony system with Industrial IT Extended Automation™ System 800xA's best-in-class productivity enhancement software. System 800xA Asset Optimization, Information Management, and Process Portal personalized workplaces optimize productivity at substantial cost savings. Where others promote "rip-and-replace" migration strategies, ABB delivers true system evolution allowing Harmony owners to build on their strong DCS foundation by providing the flexibility to implement these functions in an incremental stepwise fashion.

Introduction

SYMPHONY Harmony is a proven process control system used for demanding applications in various industries. The wide range of Harmony references includes the power generation, chemical, pharmaceutical, pulp and paper, water and wastewater, petrochemical, metals and mining, food and beverage, cement, and sugar industries.

These system owners first acquired their ABB distributed control system because it offered the best set of solutions that helped them be successful and competitive. Whether it was ease of engineering, system scalability, powerful control applications or ergonomically designed user interfaces, the system met the company's needs in an effective and efficient manner.

But markets and business conditions are constantly changing, requiring faster turnarounds, greater customization, smaller lot sizes, and lower overall costs. In today's fast paced economy, companies are under more pressure than ever to run their operation profitably – to achieve greater results with fewer resources.

With reduced capital spending, ABB system owners need to perform smarter and better at substantial cost savings. The business challenge they face is to squeeze the most productivity from the installed system by adding new functions and features, extending its useful life and the applications within it, and by reducing maintenance costs while improving overall reliability.

ABB addresses these challenges by providing new capabilities that enable Symphony Harmony system owners to achieve Operational Excellence. Symphony Harmony system products are enhanced to improve their cost/performance curves and make them more reliable while incorporating proven, new technology to enable step change benefits.

While a greenfield automation system installation can readily take advantage of the latest capabilities, an existing system installation faces many modernization challenges. These include:

- 24/7 production, short or non-existent downtime
- Upgrades must be performed without jeopardizing operation of plant or mill
- Maintenance budgets rather than large capital project funding
- Site has made significant investments in:
 - Control applications
 - User interfaces
 - Training of plant personnel
 - Standard Operating Procedures (SOP) based on the automation system
 - Validation (for the regulated industries)
 - Hardware
 - Software
 - Other intellectual property

Therefore, changes to an existing system must be limited to the specific area of interest, be risk averse, and protect the owner's investments in hardware, software, and intellectual property. In short, there must be a solid, measurable Return-on-Investment (ROI).

ABB's answer to these issues is founded in its evolution strategy. Evolution is ABB's way to deliver continuous improvement to its installed systems; allowing system owners to meet automation system business objectives in an incremental way affording the lowest risk and best ROI. It is not migration, it is not "rip-and-replace"; it is a well thought out plan, allowing system owners to adapt new capabilities at their pace, according to their need.

From a product point of view, this strategy is business as usual at ABB. Its pledge of **Evolution through Enhancement** (Figure 1) has extended the life and the Return-on-Investment of installed Harmony systems. Other vendors may talk about investment protection, but ABB's proven programs are truly unique in the industry. All told, from the introduction of Network 90® in 1980, through each of the evolutionary steps of INFI 90®, INFI 90 OPEN, and SYMPHONY™ Harmony, this family of systems represents the largest contiguous installed base of any process automation system in the world. System 800xA represents the most recent step in the on-going system evolution process.

The purpose of this document is to summarize the many opportunities available to the Harmony system owner for enhancing the value of and extending the useful functionality of their system. On the following pages are details of the enhancements available to the Harmony DCS foundation (see section "Extending the Return-on-Investment of Harmony Systems"); as well as the opportunities available to build to an extended automation scope from a Harmony DCS foundation (see section "Achieving an Extended Automation Scope with System 800xA").



Extending the Return-on-Investment of Harmony Systems

ABB continues to add traditional DCS functionality for the Harmony system. This has resulted in a variety of new functions and technology updates for Harmony products including Rack I/O modules, Bridge Controllers, communication modules, Composer system configuration tools, and operator consoles. The following sections summarize the most recent enhancements to the Harmony system.

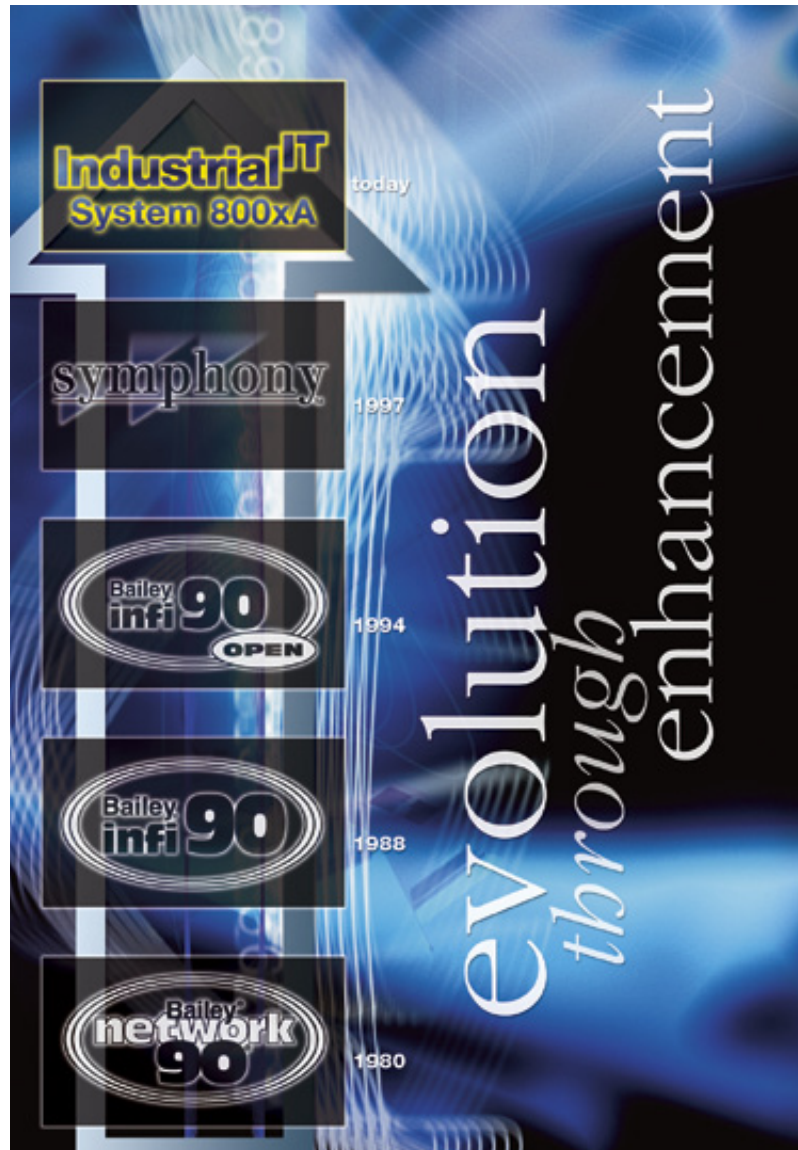

Figure 1. Evolution through Enhancement

Harmony Control, I/O, and Communications

The Harmony Rack modules (Figure 2) redesigned with modern board components and surface mount technology, are form, fit, and functional equivalents to the Network 90, INFI 90, and INFI 90 OPEN modules. This provides backward compatibility to ensure a long lifecycle for Harmony systems.



Figure 2. Harmony Rack Modules

Harmony Rack Controllers. Harmony Rack controllers have remained state-of-the-art through annual software and hardware enhancement releases. Following ABB's commitment to *Evolution through Enhancement*, the system's flagship controllers, the Harmony Bridge Controller (BRC) family, preserve existing system control logic configuration including support for all existing function code executions, custom user programs, and foreign device interfaces. This provides a predictable and risk-free evolution for the system's control execution environment.

The BRC300 and the BRC400 (Figure 3) represent the latest additions to the BRC family.



Harmony BRC Controller Features

- Form, fit & functional equivalent for Harmony rack controllers
- Deploys advanced Reduced Instruction Set Computer (RISC) microprocessor technology – Motorola 32-bit Coldfire
- Retains Harmony controller (BRC, MFP, etc.) hardware and software architecture
- Enhanced controller reliability
- Provides approximately (2x) function code execution rate vs. BRC100, (4x) vs. MFPxx, and (8x) vs. MFCxx
- Extended user configuration memory; 30,000 function blocks (BRC400 version)
- Preserves existing control logic configurations, providing predictable and risk-free evolution:
 - Function code execution
 - Custom user programs
 - Foreign device interfaces
 - Fast fail-over redundancy
- High availability and fault tolerance in a redundant pair configuration
- Controller configuration supported by the Composer engineering tool
- Supports all Harmony I/O systems, simultaneously providing support for installed I/O systems and expansions:
 - Rack I/O
 - Block I/O
 - S800 I/O (System 800xA)
- Support for Module Bus and Controlway communications

Figure 3. Bridge Controller Family (BRC300, BRC400)

Harmony Rack I/O. The Harmony Rack I/O family includes a wide variety of input, output, and signal conditioning modules. Module types, ranging from standard analog and digital I/O to specialty I/O such as turbine control, and Sequence of Events (SOE), can be combined to provide a comprehensive set of functionality to meet all market and industrial requirements. Additionally, the Harmony remote I/O capabilities have been enhanced with the addition of S800 I/O (see section “S800 I/O for Harmony” for details).

Another example of ABB's continuing commitment to protect investments made in Harmony system assets is found in the recent introduction of a Rack Remote I/O alternative. Needed to protect the more than 20 year investments made in the rack remote I/O IMRIO02 module, this new alternative minimizes the change impact to existing hardware architectures. Specifically, the new Rack Remote I/O alternative leverages newer H-Net technology for remote communications and requires minimal change to the Remote I/O interface block (FC 146). The Rack Remote I/O alternative supports multiple RIO links and can be mixed with the other Harmony I/O types: Rack, Block, or S800 I/O. The Rack Remote I/O alternative supports multiple RIO links and can be mixed with the other Harmony I/O types: Rack, Block, or S800 I/O. The Rack Remote I/O architecture is summarized in Figure 4.

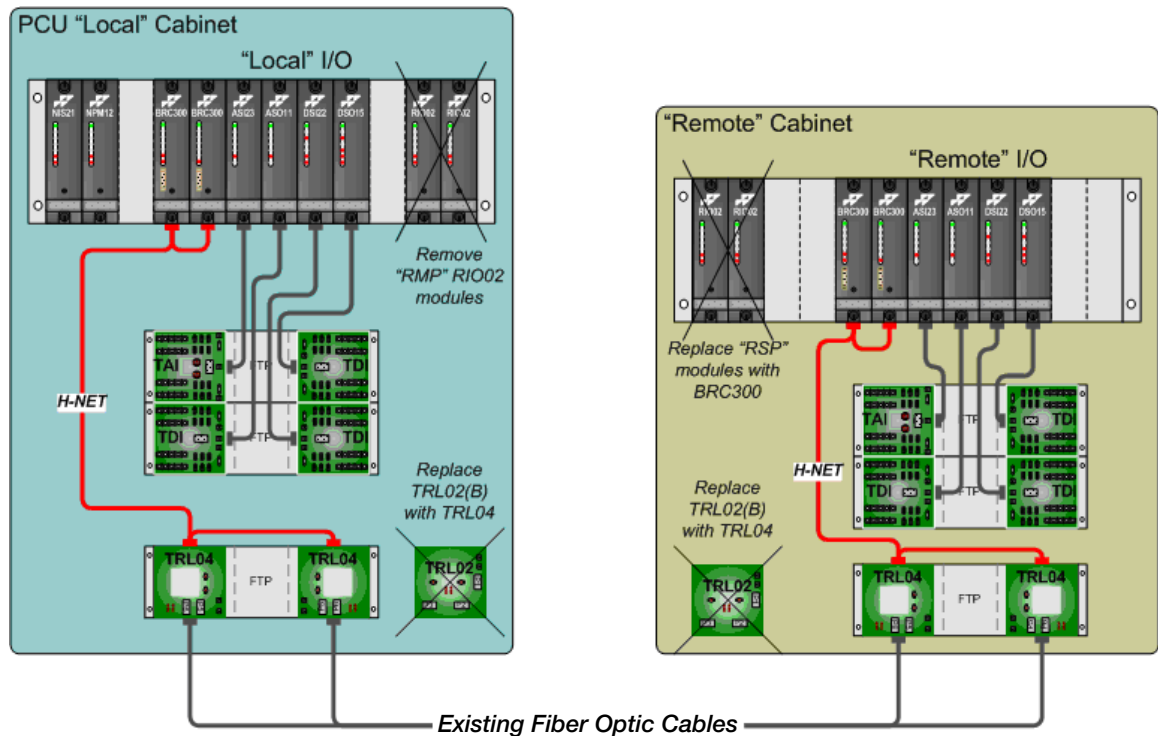

Figure 4. New Harmony Rack Remote I/O solution using H-Net

Harmony Communications. New communication modules ensure the long term viability of new and installed systems. As the flagship PCU Communication products, the INNIS21/INNPM22 modules provide significant increases to performance and capacity compared to previous generations. Additionally, new INFI-NET to Computer Interface and INFI-NET to INFI-NET Local and Remote Bridge modules are available. All of these communication modules are form, fit, functional replacements of their predecessors.

Composer Engineering Tools for Harmony

Composer is the comprehensive set of engineering and maintenance tools for Harmony systems. It provides configuration support for all controller and INFI-NET (Cnet) communication options. The working environment provided by Composer simplifies the configuration and maintenance of Harmony systems. The base product contains all the functionality necessary to create and maintain control system configurations. In addition, it includes applications that support graphic configuration and database management of all current operator console offerings.

Composer's multiuser client / server architecture allows configuration information to be accessed, created, and modified simultaneously by different users. Composer's project explorer provides the user with the ability to organize, navigate, and manage Harmony system configuration documents. Once documents are located, Composer's explorer can be used to launch the editors which are used to develop Harmony configurations.

Composer tools include:

- **View and Monitor:** Provides the ability to view control configurations with live data from any Windows based web browser application on the network (Figure 5)
- **Online Maintenance Tools:** Provides users with the ability to trouble shoot, perform diagnostics, and maintain the operating Harmony system
- **Standalone Configuration Viewer:** Offers users an option to view CFG files or view and tune configurations in a controller without requiring Composer software or projects
- **Power Tools:** Suite of add-on applications that extends the capabilities of Composer and reduces the amount of time required to engineer and configure a Harmony system. Applications include Control Logic Editor, Revision Manager, Automatic Drawing Generator, and Advanced Trend (runtime monitoring and tuning)
- **Batch Data Manager (BDM):** A family of engineering tools used for creating, editing, managing, downloading, and debugging batch, sequential, and user defined function code configurations. BDM is discussed further in the section "System 800xA Production Management for Harmony"

To learn more about the Composer Engineering Tools, please refer to the Composer Data Sheet, 3BUA000304Rxxxx.

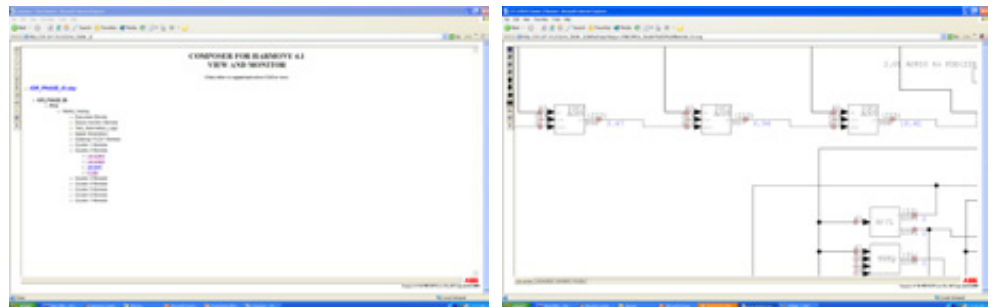

Figure 5. Composer View and Monitor Mode

Operator Consoles

Harmony operator console evolution dates back to the early 1980s with the introduction of the Operator Interface Unit (OIU). Since then, ABB has supported console enhancements and graceful evolution to newer technology through tag database and process graphics compatibility conversion services. The current console portfolio includes Conductor NT and 800xA Process Portal (see section "System 800xA Process Portal for Harmony Systems" for operator console details).

Achieving Extended Automation Scope with System 800xA

Easy integration of System 800xA's productivity enhancing applications, such as Asset Optimization, allows Harmony system owners to tap into their assets' unused productivity to achieve a sustainable competitive advantage (Figure 6). Through an incremental, stepwise evolution process, productivity gains can be realized at a substantial cost savings. The following sections discuss the 800xA Operations, Device Management, Asset Optimization, AC 800M Control and I/O, and Information Management solutions available to Harmony system owners.

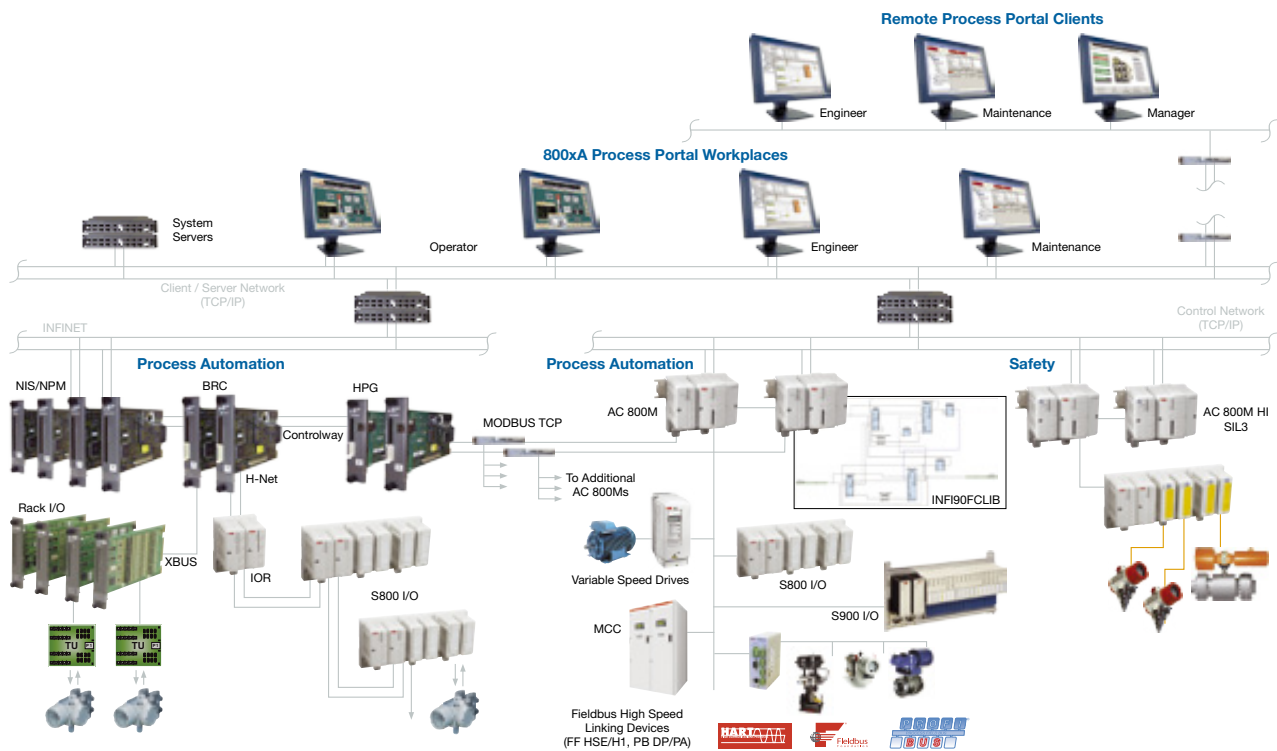

Figure 6. Extending Harmony Functionality with System 800xA

System 800xA Process Portal for Harmony Systems

System 800xA Process Portal, the industry’s most comprehensive operations software for automation, offers an intuitive, easy-to-use system interface. Providing direct access to relevant information through contextual navigation, 800xA Process Portal facilitates timely and informed decision-making.

Unique to System 800xA Process Portal is its ability to gather information from multiple plant sources and transform it into relevant information for a diverse set of users such as maintenance technicians, process engineers, production managers or plant operators (Figure 7).

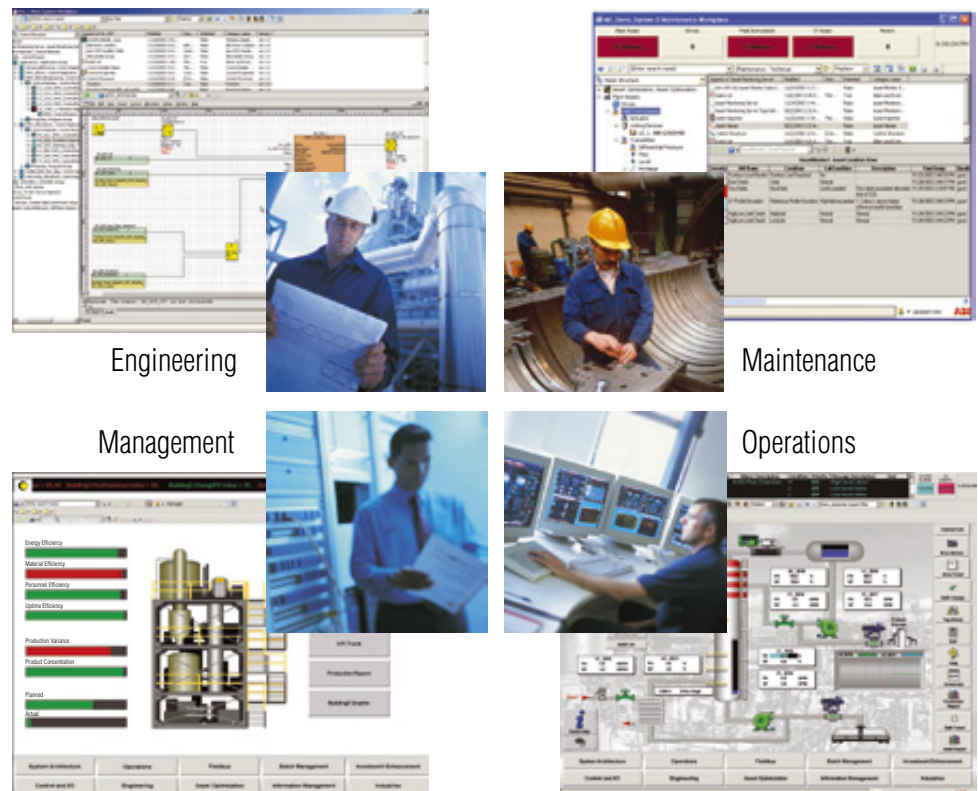

Figure 7. Personalized User Workplaces

The enabling technology for this data access, storage, and management is ABB’s patented Aspect Object™ framework. Aspect Objects relate all plant data; the aspects, to specific plant assets; the objects. For example, aspects are informational items associated with objects, such as I/O definitions, engineering drawings, process graphics, reports, trends, etc., that are assigned to each object in the system. Aspect Object navigation presents the entire production facility in a consistent, easy-to-view fashion. This allows a single window environment to include smart field devices, asset optimization functions, information management, batch management, safety systems, and manufacturing execution system (MES) applications.

System 800xA Process Portal features include:

- Personalized Workplaces for Focused Information Access:** Workplace layouts are adjusted and optimized to user preferences and needs with individualized menus, toolbar contents, and display locations. Operator, maintenance, engineering, and management personnel are at ease and perform their responsibilities efficiently using Windows management functions, such as safe areas and pinning and stacking priorities, thus minimizing operation errors.

- Intuitive and Flexible Navigation for Fast Information Access:** Familiar web browser tools provide quick access to displays and information. Favorites, history lists, shortcuts, and hot buttons provide navigation through a process production facility quickly and accurately. Use of the right mouse button provides access to additional details (Figure 8).
- Integrated Data for Informed Decision-Making:** ABB extends the automation reach by integrating information from a wide range of ABB applications, other automation systems, and business systems into System 800xA on common displays. This single window provides users a much broader view of the facility from which to make more informed decisions (Figure 9).
- Comprehensive Operator Functionality for Reliable Control:** System 800xA Process Portal provides a complete set of operator functions that includes realistic process graphics with standard faceplates, superior trending capabilities, intelligent alarm and event handling, production reporting, and remote messaging (Figure 10).



Figure 8. Intuitive and flexible contextual navigation



Figure 9. Integrated data for informed decision-making

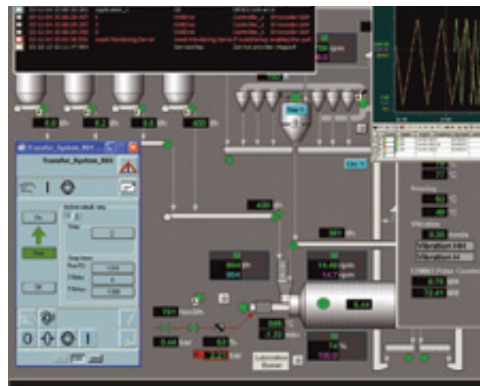

Figure 10. Comprehensive operator functionality for reliable control

These personalized workplaces can coexist with existing Harmony operator consoles. This provides the option to immediately gain added benefits from System 800xA Process Portal functionality without completely evolving the existing Harmony operator consoles. However, Process Portal also offers an extended operations environment with comprehensive process information for the system operator. It does this while preserving Harmony system data, standard Harmony displays, and operator functions.

The following paragraphs describe unique Harmony Process Portal features. For those requiring more details regarding general Process Portal functionality, please refer to the Industrial IT System 800xA Operations Overview document (#3BSE 034823).

Preserving Harmony Tag Configuration. The Harmony Composer engineering tool provides the basis for the 800xA Process Portal configuration. A simple importing process from Composer sets up the Harmony tag configuration data and standard Harmony informational views within Process Portal.

Preserving Harmony Process Graphics. ABB provides options for existing Harmony process graphics. A service is provided to convert existing graphics for those users who need to maintain current operator process visuals and navigation. Optionally, ABB can refresh current visuals with the latest graphics technology thereby providing operators with an enhanced view of the process.

Harmony Standard Informational Views. The Harmony tag importing process automatically creates control faceplates, trend displays, block details, module status, operating parameters, and other Harmony specific, standard informational aspect views (Figure 11).

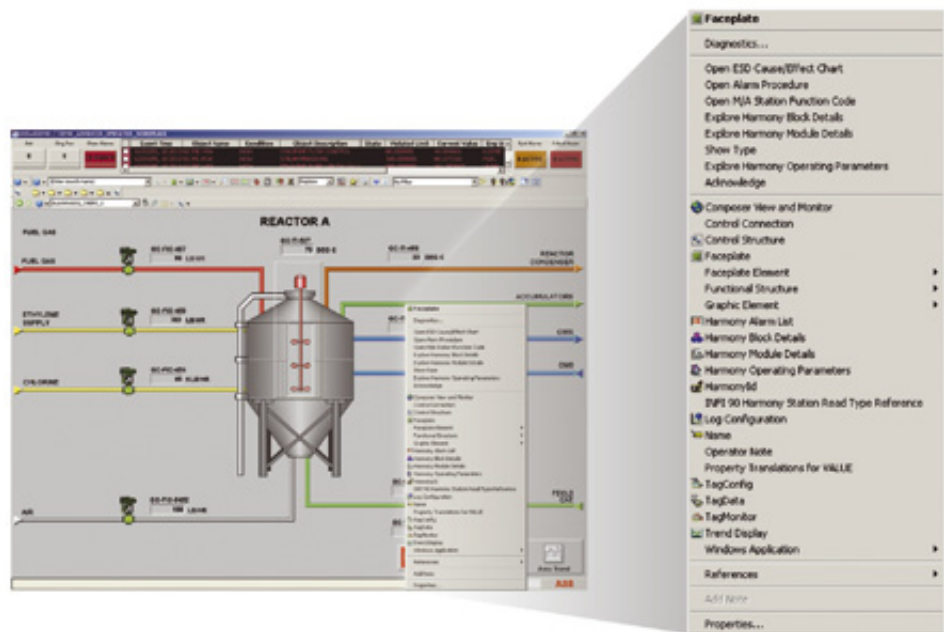

Figure 11. Process graphics with contextual navigation to all Harmony control information

The following Process Portal aspects can be easily modified to meet any operational requirement.



Figure 12. Control faceplate views: Normal and Extended

■ **Faceplates.** Faceplates include several views; from normal for standard control to point display view for detailed control. Harmony Point Displays (Figure 12) are expanded faceplates that include trend elements that display the trace of the process value or state. Point displays occupy the extended slot of the faceplate control of those tag types. These faceplates are automatically configured during the data conversion process. Each of the Harmony tag types listed below (unless noted) has an associated faceplate and extended point display.

- Device Driver (DD)
- Multi-State Device Driver (MSDD)
- Remote Control Memory (RCM)
- SOE Report Trigger Tag
- Remote Manual Set Constant (RMSC)
- Remote Motor Control Block (RMCB)
- Station
- Analog
- Enhanced Analog In
- Enhanced Analog Out
- Digital
- Enhanced Digital In
- Enhanced Digital Out
- Data Acquisition Analog (DAANG)
- Data Acquisition Digital (DADIG)
- ASCII Text String (normal faceplate display only)
- Text Selector (normal faceplate display only)
- Analog Export
- Digital Export
- Module Status (normal faceplate display only)
- Harmony Server Tag (normal faceplate display only)
- PhaseX (normal faceplate display only)

■ **Block Details.** The Block Details aspect (Figure 13) inspects function blocks within a selected controller. Grouped within a series of tabs, the Block Details aspect displays the block's specifications with tuning options, its outputs, and additional related function code information. Tabs include:

- Specifications – Specification data (i.e. references to another function block output, tunable / non-tunable parameters)
- Outputs – Current output value(s) of the FC block
- Description – Description of the FC
- Address – Enter a new block address
- NextBlock – Jump to the next block address in the module

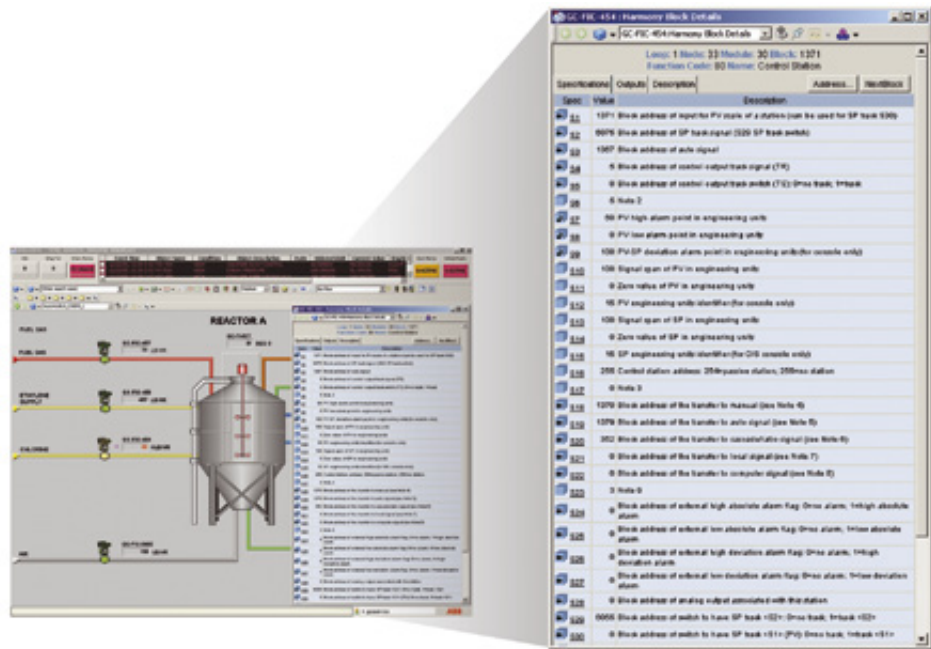

Figure 13. Block details view

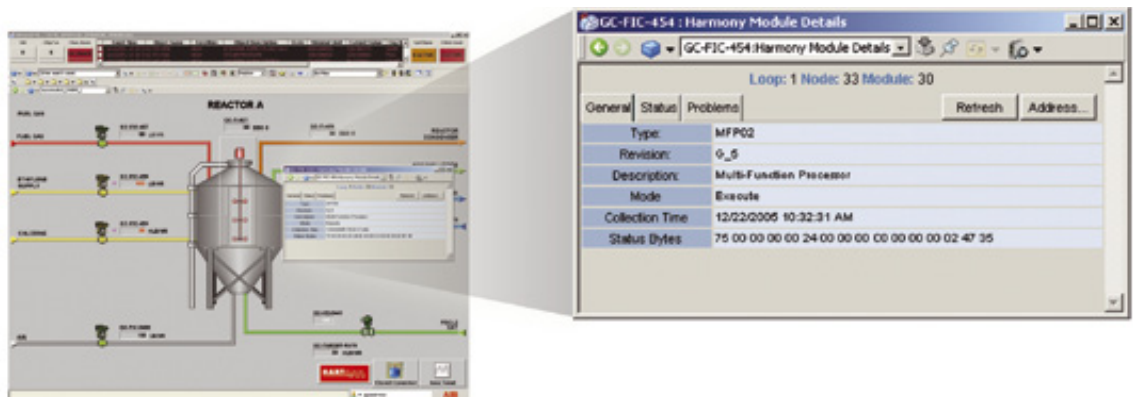

Figure 14. Module Status View

- **Module Details.** The Module Details aspect (Figure 14) provides detailed information about the operational status of a selected Harmony module. Detailed information is available through the following navigation tabs:
 - General tab displays the Type, Revision (firmware), Description, Mode, Collection Time, and Status Bytes
 - Status tab displays a list of status error messages that apply to the selected module at the time of the last scan
 - Problems tab displays a list of problem report messages that apply to the selected module at the time of the last scan
- **Operating Parameters.** The Operating Parameters aspect allows interaction with the Harmony Tag including examination of key parameters, red tagging, inhibiting, and value substitution (Figure 15). Tables 1 and 2 summarize the operating parameters included within the General and Harmony Tabs respectively. An important feature of the operating parameters aspect is the Manual Inhibit option of the General tab. This is used to disable event reporting for the tag in the same way

as an automatic inhibit. Substitute Value is used to enter a substitute value for the tag. When a substitution is applied, “scan” is automatically turned off and the value in the controller is unchanged. The substitute value is only performed at the Operator Workplace level. Only operators with the proper, user selected security level can access this function. The Red Tag feature is available on controllable tag types that support red tagging. Red tagging is a method used to place a tag out of service (for maintenance or other purposes) in a way that prevents it from being put back into service by unauthorized users. Typically only a limited number of users is permitted to implement this feature. Web pages are defined for each object type for display of operational data. This also allows the user to change the state of the object (such as red tags), utilize manual inhibiting of alarms, and substitute values.



Figure 15. Operating Parameters view

Field	Description
Type	Tag type (Harmony station)
Description	Information entered during configuration that further describes the function of the tag
Security group	Security group that the tag belongs to
Alarm status	Selected if the tag is reporting an alarm. This is a single overall alarm status indication
Quality	Information reported from the system about the quality of the tag
Tag inhibition	Information about the inhibit status of the tag. A tag inhibit disables event reporting for the tag
Inhibit Tag	Tag that causes inhibit when the inhibit value is reached
Inhibit Value	Value set during configuration that causes inhibit
Overall Inhibit	Indicates that the tag is inhibited
Auto Inhibited	Selected if tag is automatically inhibited by another tag in the system
Manual Inhibit	Enable to manually inhibit event reporting for the tag
Manual Inhibited Time stamp	Time when the tag was manually inhibited

Table 1. Operating Parameters – General tab

Field	Description
Loop	Loop number from 0 to 250 that identifies the communication network (loop) of the Harmony control unit
Node	Node number from 0 to 250 that identifies the interconnection point on the communication network
Module	Module number from 0 to 31 that identifies the device within the Harmony control unit
Block	Function block location from 0 to 31,998 that identifies the location of a specific function block in the Harmony configuration (controller)
Disestablished	Selected if the tag is disestablished in the Cnet-to-computer interface. A tag becomes disestablished when a substitute value has been entered
Substituted Value	Value of tag is manually substituted
Suspended	Enable to have the system ignore the tag
Suspended Time stamp	Time when the tag was suspended (manually or substituted)
Exception Count	Number of exception reports processed for this tag.
Spec Time Stamp	Time when specification data was received from the controller

Table 2. Operating Parameters – Harmony tab

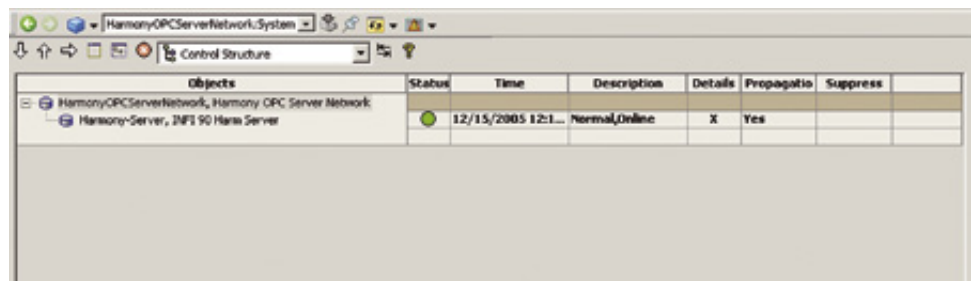

Figure 16. System Status Viewer

- **System Status.** The System Status Viewer (Figure 16) is used to monitor the status of the Harmony system applications. The description field can display one or all of the following messages:
 - Alarm State (Normal or Alarm) - This displays normal as long as there are no other errors. If the status is offline or any of the other errors exist, then it displays alarm
 - Status (Online or Offline) - Indicates that the CIU is Online or Offline
 - CommErr - Indicates that there is some kind of communication error
 - InternalErr - This is the internal error in the configuration
- **Composer “View and Monitor.”** The Harmony Composer Configuration View and Monitor function is integrated with 800xA Process Portal. With a right-click on the graphic tag, the associated Control Logic Diagram can be viewed with live data monitoring. This is a “view only” function that maintains high security and the integrity of the control logic configuration.
- **Sequence of Events.** Harmony’s Sequence of Events (SOE) system enables plant personnel to closely monitor critical digital points where the sequence of changes of state for points or groups of points is critical, and must be as accurate as possible.

SOE systems allow collection of precise state transition event data originating in a Sequence of Events Recorder (SER), or a Distributed SOE system within the control system. In the Harmony SOE system, digital state transitions are recorded and time stamped to one millisecond resolution at the time of occurrence. SOE reports (Figures 17 and 18) can be created automatically, based on a triggered value of a tag property. Report action parameters may be configured. These parameters include: Time Limit, Isolated Priority, Attempts, System Messages, Report Templates, and Export Paths. This feature allows the flexibility to configure specific reports based on specific events. SOE reports may be saved and reviewed later, and/or printed by any Client on the system that has Microsoft Excel installed. When integrated with 800xA Information Management, reports may be archived for long-term storage.

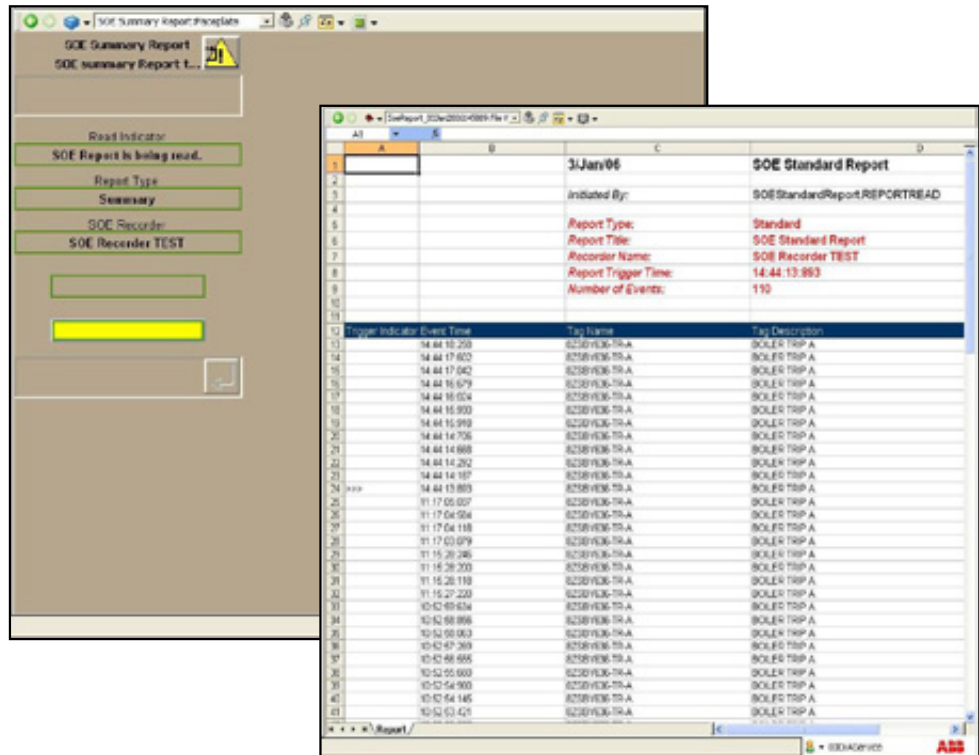

Figure 17. SOE Report

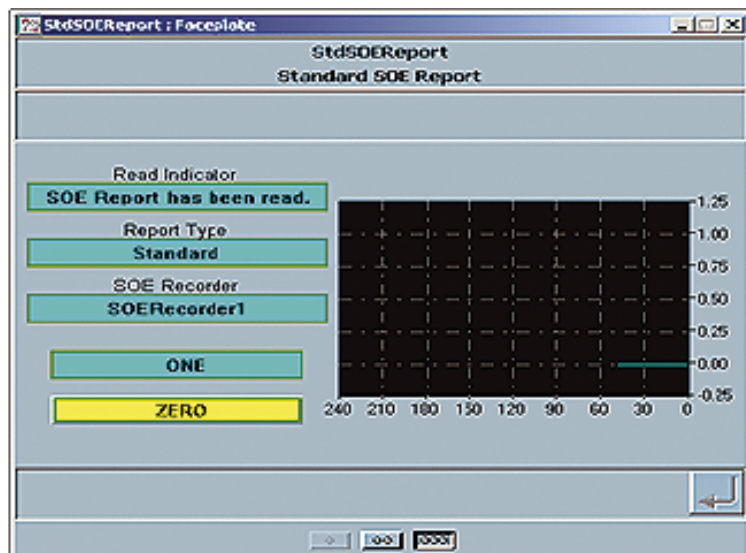

Figure 18. SOE Report Trigger Point Display

S800 I/O for Harmony

Harmony remote I/O capabilities are expanded with S800 I/O. To facilitate local mounting to sensors in the plant, the S800 I/O family is designed with a small, modular DIN form factor footprint.

S800 I/O provides options for all signal types ranging from basic analog and digital inputs and outputs to pulse counters and intrinsically-safe applications. S800 I/O supports Sequence of Events functionality with one millisecond accuracy event time-stamping at the source. It communicates with the Harmony Bridge Controller via Hnet communications and the Harmony IOR-800 module (Figure 19). Redundant communication provides fault tolerant connection to S800 I/O. Standard Composer tools configure the Harmony IOR-800 Interface module, S800 I/O, and their individual I/O channels. A single Harmony Bridge Controller simultaneously supports both Rack I/O and S800 I/O for simple expansions and ease of system evolution.

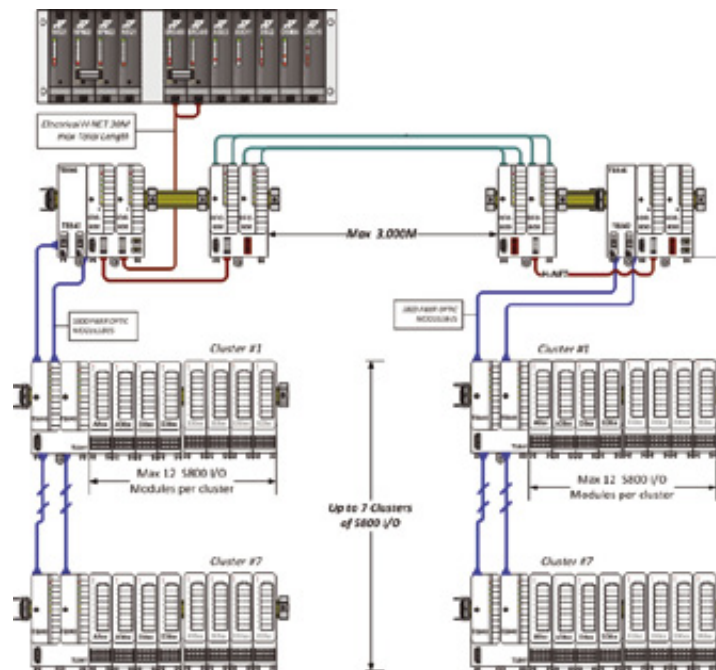

Figure 19. IOR Interface Module and S800 I/O Modules

AC 800M Control and I/O

Through their modular design, AC 800M controllers and associated I/O options contribute to lower costs, higher engineering quality, and higher operating efficiency. Equally effective for small hybrid systems and large, integrated automation applications, the modularity of the subsystem results in higher return on assets by providing the flexibility to choose the specific functions required to meet the automation need. Designed for plant automation and SIL2 and SIL3 safety applications, the AC 800M controller family provides Harmony system owners with the opportunity to expand their automation system capabilities. Additionally, the AC 800M controller and associated I/O modules support industry standard interfaces, network protocols, and fieldbuses allowing a wide range of devices and systems to be accessed and their resident information to be used to produce tighter and more reliable control solutions.

To learn more about the AC 800M controller and its I/O subsystems, please refer to the System 800xA 5.0 Control and I/O Overview document, 3BSE047351.

Harmony system owners can now take advantage of all the powerful and flexible capabilities of AC 800M controllers while protecting the investments they have made in their existing control assets. Whether replacing aging PLCs or evolving an existing

process control area with fieldbus devices, ABB's control evolution products minimize production risk while providing incremental and stepwise evolution paths.

These products include:

- Harmony PCU Gateway – HPG800.** The HPG800 rack module addresses the needs of those system owners who want to extend their Harmony systems using AC 800M controllers. It is a high performance, high capacity rack module that provides a high speed, robust, real-time, peer-to-peer communication interface between Harmony and AC 800M controllers. The HPG800 communicates with Harmony controllers over Controlway / INFINET via standard function blocks. Harmony Gateway Software (HGS) maps INFI 90 function blocks to MODBUS points and communicates those points over a 100 MB Ethernet port using MODBUS TCP protocol. The CI 867 CEX module provides the physical MODBUS TCP interface to AC 800M. The architecture and communication paths of the interface are shown in Figure 20 while the module's features are summarized in Figure 21.

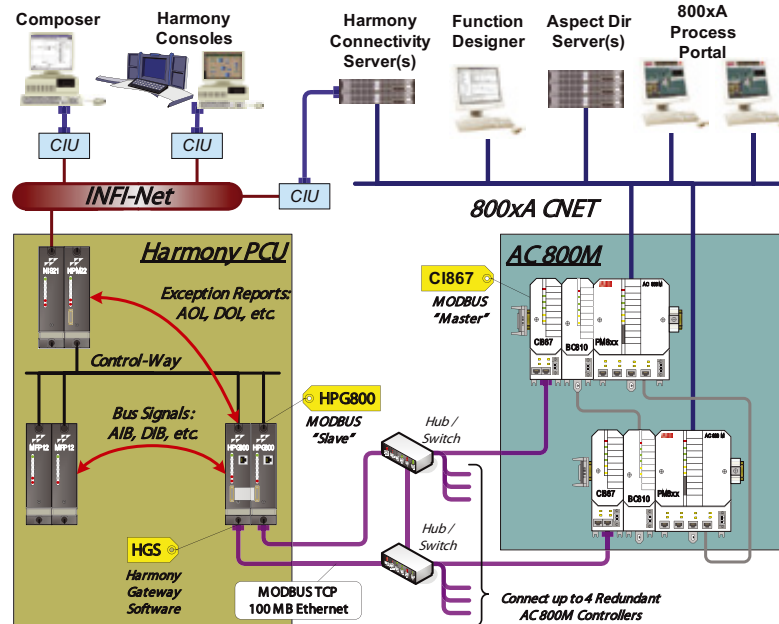
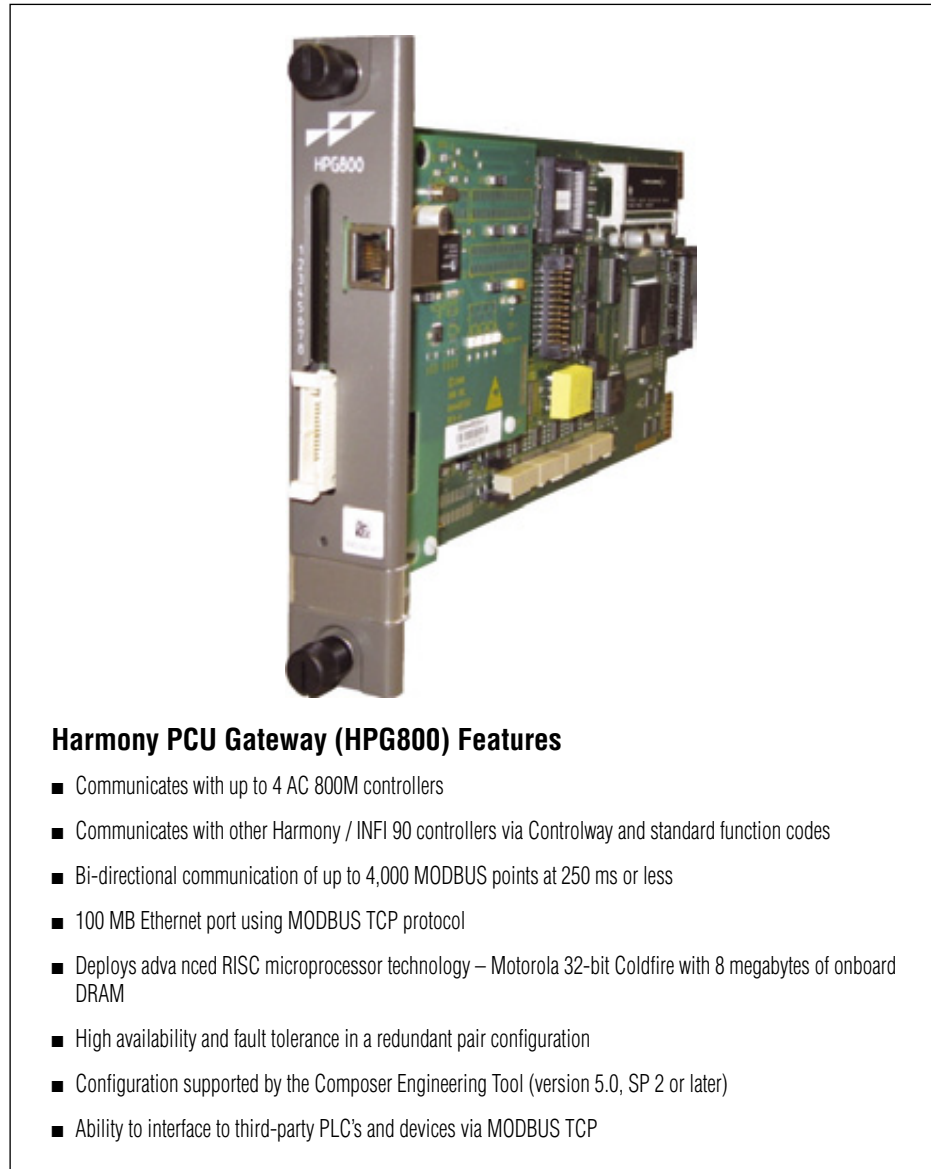

Figure 20. HPG800 connects Harmony controllers to AC 800M controllers



Harmony PCU Gateway (HPG800) Features

- Communicates with up to 4 AC 800M controllers
- Communicates with other Harmony / INFI 90 controllers via Controlway and standard function codes
- Bi-directional communication of up to 4,000 MODBUS points at 250 ms or less
- 100 MB Ethernet port using MODBUS TCP protocol
- Deploys advanced RISC microprocessor technology – Motorola 32-bit Coldfire with 8 megabytes of onboard DRAM
- High availability and fault tolerance in a redundant pair configuration
- Configuration supported by the Composer Engineering Tool (version 5.0, SP 2 or later)
- Ability to interface to third-party PLC's and devices via MODBUS TCP

Figure 21.

To learn more about the HPG800 peer-to-peer rack module, please refer to 3BUS094832.

- **INFI90FCLib for AC 800M.** INFI90FCLib is an AC 800M evolutionary library that contains INFI 90 Function Codes. The purpose of the INFI 90 Function Block library is to allow Harmony system owners to protect the intellectual property embedded within their existing controllers. Specifically, the library is designed to make evolution of Harmony control applications to AC 800M straightforward and simple. The INFI90FCLib does this by providing an equivalent function block in AC 800M for the function codes from Harmony. Table 3 lists the IEC 61131-3 Function Block Types (FBTs) provided in the INFI90FCLib.

FC#	INFI 90 FC	AC 800M FBT	FC#	INFI 90 FC	AC 800M FBT
1	F(n)	FnGen	97	REDDI	RedDI
3	F(t)	LeadLag	98	SLSEL	SLSEL
4	PULPOS	PulsePosn	110	RNG5	Rung5
5	PULSE	PulseRate	111	RNG10	Rung10
7	SQRT	Sqroot	112	RNG20	Rung20
8	VELLIM	RateLimiter	116	JUMP	JumpMCR
9	T	XferReal	117	RECIPB	RecipeBool
12	H//L	HiLowComp	118	RECIPR	RecipeReal
15	SUM	Sum2Real	119	BMUX	MuxBool
18	PID	ErrPID	120	RMUX	MuxReal
19	Δ PID	DeltaPID	123	DD	DeviceDriver
21	M/A-BAS	BasicStation	124	SEQMON	SeqMon
30	AOL	AOL	125	DEVMON	DevMon
31	TSTQ	TSTQ	126	RDEMUX	DMuxReal
32	TRIP	TRIP	129	MSDD	MSDD
34	S/R	SRMem	134	MULTIMON	MULTIMON
35	TD-DIG	TimerBool	135	SEQMGR	SEQMGR
36	QOR	QOR	136	RMC	RMCB
45	DOL	DOL	141	SEQMST	SeqMstrSlv
52	T-INT	XferDint	142	SEQSLV	SeqMstrSlv
58	DELAY	DelayReal	151	TEXT	TexSel
59	T-DIG	XferBool	156	APID	APID
61	BLINK	Blink	160	Smith	ISC
62	RCM	RCM	161	SEQGEN	SeqGen
65	DSUM	DSum	165	MOVAVG	MovAvg
68	REMSET	REMSET	166	INTEGR	Integrator
69	TSTALM	TSTALM	167	POLY	POLY
80	M/A	Station	168	INPOL	INPOL
81	EX/MFC	Exec	171	TRIG	TRIG
85	UP/DN	UpDnCount	172	EXP	EXP1
86	ETIMER	ElapTimer	173	POWER	POWER
90	EEX/MFC	ExExec	174	LOG	Log1
95	MODSTAT	MODST	177	DAANG	DAANG
96	REDAI	RedAI	211	DADIG	DADIG

Table 3. INFI90FCLib 2.0-0 List of FBT's

Table 4 depicts the standard AC 800M system functions that provide equal or superior functionality as those provided by the INFI 90 function codes. When one of the following INFI 90 function codes is applied, the corresponding AC 800M system functions are used with equal or better results going forward.

FC#	INFI 90 FC Name	AC 800M System Function
2	A	real variable
6	LIMIT	limit(real)
10	HISEL	max(real)
11	LOSEL	min(real)
14	SUM4	add(real)
16	MULT	mul(real)
17	DIV	div(real)
33	NOT	not(bool)

FC#	INFI 90 FC Name	AC 800M System Function
37	AND2	and (bool)
38	AND4	
39	OR2	or (bool)
40	OR4	
50	ON/OFF	boolean variable
52	A-INT	dint variable
66	TREND	not required in AC 800M
179	ETREND	

Table 4. 800xA System Functions vs. INFI 90 FC's

Function Designer is used to configure and maintain INFI90FCLib control configurations. Its Function Diagrams (FD) provide the same “look and feel” graphical documentation as Composer’s Control Logic Diagrams (CLD) have done for INFI 90 FC based control logic within Harmony. Figure 22 compares a CLD with its converted FD counterpart. By preserving the “look and feel” of the control logic documentation, engineering re-training is minimized. Also, by providing an automated conversion service, engineering costs are further reduced by protecting the investments system owners have made in their documentation assets.

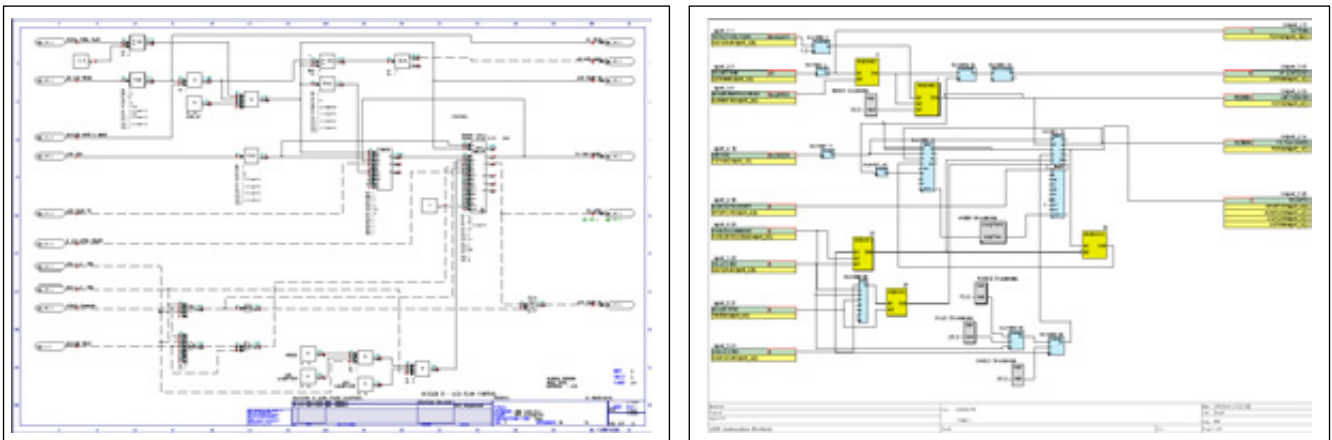

Figure 22. CLD (left) Conversion to Function Diagram (right)

INFI90FCLib key features include:

- Match 1-for-1 each INFI90 Function Code to AC 800M Function Block
 - Based on same field proven / field tested function code algorithms
 - Inputs, outputs, and parameters all provide same behavior
 - No re-tuning of converted loops required
- Same operator faceplates as those used with 800xA for Harmony
- Same graphical “look and feel” within AC 800M’s engineering tool Function Designer
- Function Designer standard loop templates provided
 - Basic PID Loop
 - Basic Cascade Loop
 - Basic Valve Control Loop
- Compatible with AC 800M’s other IEC 61131-3 control languages (Sequential Function Charts, Ladder Diagrams, Structured Text, and Instruction Lists)

To read more about AC 800M's INFI 90 evolutionary library, please refer to the INFI90 Function Code Library for AC 800M – Application Overview, 3BUS094839.

- **S800 I/O – Harmony Termination Unit (TU) prefabricated cables.** To minimize the risk and costs of re-terminating field wires, ABB has created a family of cables that preserves the investments made in standard Harmony field wiring terminations. These prefabricated cables allow for the I/O module upgrade to S800 I/O without ever touching the field wires. The cables are used in place of the traditional NKTU cables. They connect the existing TU to S800 I/O modules via standard cable plug-ins. S800 I/O cables exist for 24 VDC Digital I/O, 4-20 mA/DC Analog I/O, TC, mV, RTD I/O (ASM01, ASM02, and ASM03) termination units. Similar solutions exist for Harmony Block bases (AIN, AOT, DIN, and DOT).

Whether replacing aging PLCs or incrementally upgrading older Network 90 / INFI 90 based controllers, especially AMM, LMM, COM, and MFC modules, these control evolution products allow for seamless evolution to AC 800M – S800 I/O without the costs and risks associated with “rip-and-replace” controller upgrade methods (summarized in Table 5).

Traditional “Rip and Replace” Upgrades	ABB INFI90FCLib for AC 800M upgrades
Re-engineering or translation of control applications	Minimal to no engineering required
New algorithms result in new process control behaviors	Process control is same as before
Long commissioning and start-up periods (re-configuration and re-tuning of loops)	Minimal commissioning and start-up (no re-tuning of loops)
Create new documentation	Documentation converted and enhanced
Results in: <ul style="list-style-type: none"> • Greater loss of production • Increased risk • Higher project costs 	Results in: <ul style="list-style-type: none"> • Minimal loss of production • Minimal risk • Lower project costs

Table 5. By avoiding high project costs and production risks, ABB control evolution upgrades cost 60 – 80% less than “rip-and-replace” alternatives

System 800xA Device Management for Harmony

System 800xA's Device Management features (Figure 23) lower lifecycle costs through significant savings in the design, implementation, and operation of field equipment. The harnessing of untapped potential from the substantial installed base of HART® devices conforms with the ARC Advisory Group analysis that: “Users can employ many of their HART field devices with new generation automation architectures, making the migration to a new process automation system more economical while increasing the availability of intelligent data that has long been under utilized.”



Figure 23. System 800xA's Device Management

Digital information from HART devices is accessed by the System 800xA Fieldbus Management tools that physically connect to HART multiplexer units. These multiplexers receive HART device data by cable connections from standard Harmony Termination Units (Figure 24). ABB's HART solution supports device parameterization and remote monitoring of signal status and process variables. It also supports diagnostic information through use of device specific Device Type Managers (DTMs), which are supplied by the respective device manufacturers. In addition, the tight integration of HART devices within Harmony enables improved device maintainability through asset monitoring and optimization.

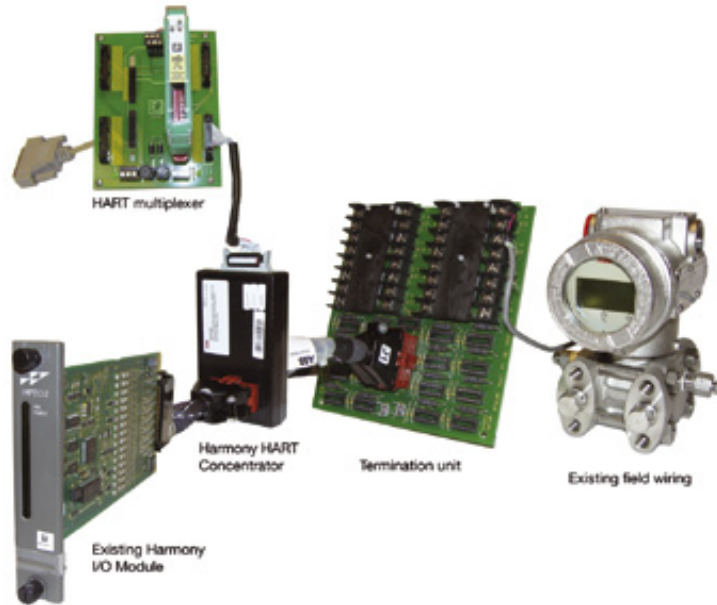

Figure 24. Simple Cable Connections Provide Access to System's Smart Device's HART Data

FOUNDATION Fieldbus and Profibus interfaces are available through the System 800xA AC 800M controller.

For more details, please refer to the System 800xA Device Management Overview, 3BDD013081.

System 800xA Asset Optimization for Harmony

With access to installed HART field device information, Harmony system owners can take full advantage of System 800xA's Asset Optimization features. The application (Figure 25) exploits the wealth of field resident information accessible through HART / Fieldbus and higher-level systems to access and document equipment conditions in real-time. In addition to field devices, System 800xA asset monitoring features inspect the health and status of the operations network, including networking equipment such as PCs, routers, printers, etc. These functions enable personnel to implement proactive and predictive maintenance services. Additionally, the software seamlessly integrates plant maintenance and calibration management systems to greatly reduce the time to repair through streamlined work processes.

System 800xA Asset Optimization highlights include:

- **Complete Asset Optimization:** Provides a higher return on all plant assets through optimized remediation work processes and early detection of failure via its single environment for engineering, operations, and notification.
- **Automatic Monitoring of Maintenance Conditions and Automatic Alarms:** Real-time monitoring of asset Key Performance Indicators (KPI's) facilitates fast, reliable implementation of corrective actions.
- **Plant-Wide Adoption of Predictive and Proactive Maintenance Strategies:** Collects, aggregates, and analyzes real-time plant asset information to provide advanced warning of degrading performance and impending failure.
- **Consistent Reporting of Plant Asset Health Status:** Reporting features provide visualization of current health conditions. Analysis features provide the ability to drill down to root cause of failure.
- **Reduced Time to Repair through Optimized Work Processes:** Integration of disparate Computerized Maintenance Management System (CMMS) data, calibration system data, condition monitoring system data, and control system asset data provides users a single application view, leading to quick and efficient assessment of maintenance needs and status.

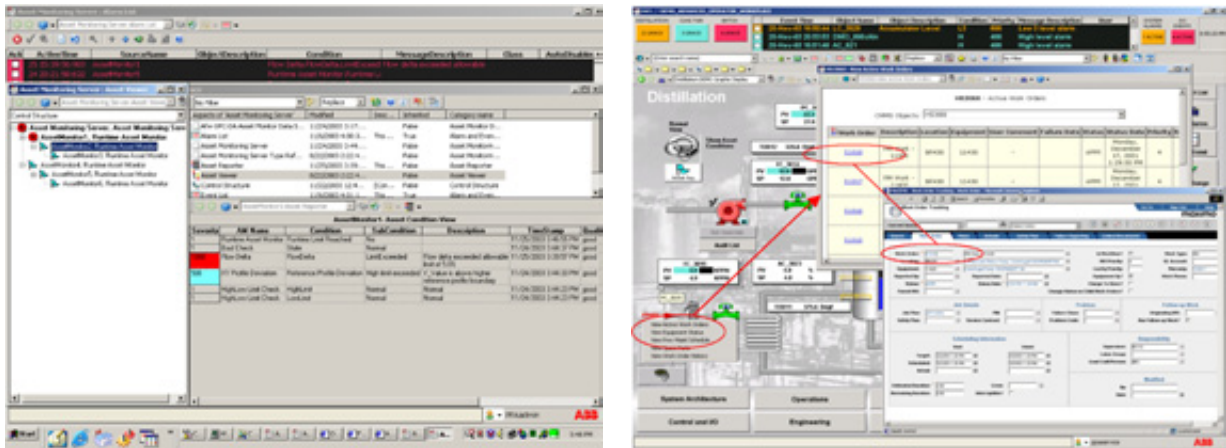

Figure 25. Asset Optimization

Additionally, 800xA Asset Optimization reviews the health and condition of the Harmony control network. It provides detailed information on Harmony Process Control units, controllers, bridges, all modules in the system, module/loop faults and overall performance (Figure 26).

800xA Asset Monitoring leverages the diagnostic information resident in the system's traditional diagnostic views for Harmony Control Network and individual system nodes (PCU). These displays provide information about current Harmony equipment sub-conditions, severity, asset monitor status, fault report availability, and work order availability when integrated with the plant's CMMS system.

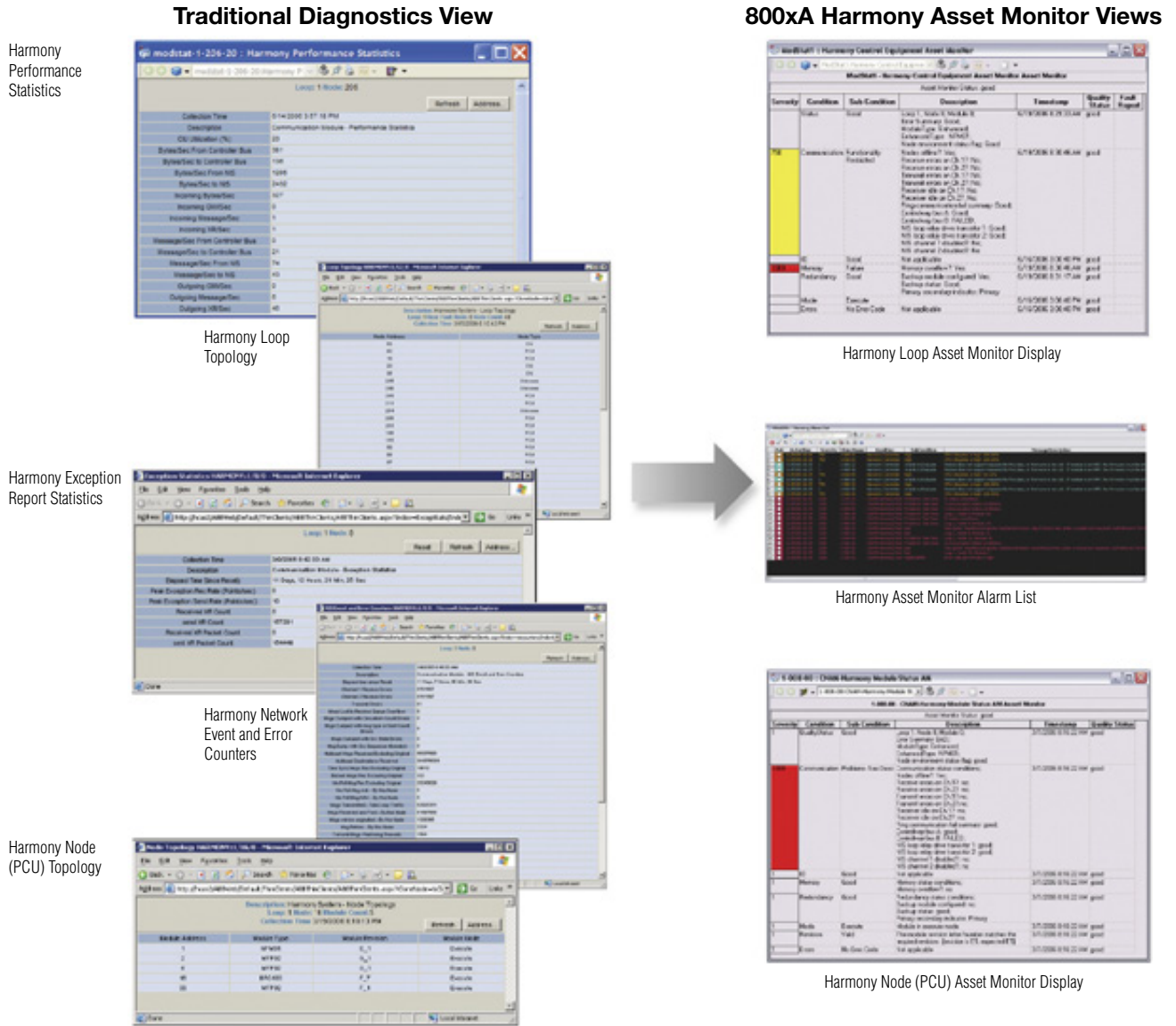

Figure 26. Harmony Control Network Health and Status Reporting

For more details, please refer to the System 800xA 5.0 Asset Optimization Overview, 3BUS094382 and the System 800xA Asset Optimization Advanced Harmony Control System Monitoring Datasheet, 3BUS094351.

System 800xA Production Management for Harmony

The 800xA Production Management suite automates, monitors, controls, and documents compliant with cGMP (current Good Manufacturing Practices) manufacturing processes. This enables users to achieve operational excellence in real-time manufacturing execution, quality, and performance management. ABB's production management capabilities are built to ISA S88, IEC 61512, IEC 61131-3 and ISA S95 standards.



800xA Production Management provides batch production management solutions, delivering unsurpassed batch-to-batch consistency, quality, and productivity. These measurable results are achieved through an unmatched level and scope of batch control integrated with scheduling, electronic batch records, inventory management, quality control, HSI, history, and controllers. Whether a process is manual, automated or both, 800xA Production Management offers solutions for stand-alone environments or for integrated operation with ERP, MES, etc.

The Batch Management component of 800xA Production Management is a powerful application software package for configuring, scheduling, and managing batch operations. As such, 800xA Batch Management provides:

- Real-time resource management
- Flexible on/off-line recipe management
- Batch data collection and history integrated with 800xA Information Management

The 800xA Batch Management server supervises execution of control recipe procedures. The server sends formulation data and issues commands to equipment phase logic via the PHASEX function block running in Harmony controllers. The PHASEX block executes the equipment phase logic and communicates status information to the batch server.

For more details, please refer to the 800xA System Batch Management Overview, 3BUS092077.

Batch Data Manager Tools (from Composer for Phase Logic). Batch data manager (BDM) is the family of engineering tools for creating, editing, managing, downloading, and debugging batch equipment phase logic for Harmony systems. At the heart of BDM is the Batch 90™ programming language which enables the engineer to create equipment phase logic using clear, concise, natural syntax control statements.

Batch 90 layers on top of the regulatory and discrete device control function code logic of Harmony. Equipment phase logic to change controller set points, turn discrete devices on and off, change modes, and other equipment supervisory operations is written in Batch 90. The PHASEX function code provides the programmatic interface between Batch 90 and regulatory and discrete control configured using INFI 90 function blocks.

System 800xA Information Management for Harmony

To achieve a sustainable competitive advantage, manufacturing and non-manufacturing businesses must be able to adapt quickly to market changes. This makes the timely collection and distribution of reliable information to the plant's decision-makers critical. System 800xA Information Management provides the ability to collect and securely store and present business as well as process data from all plant data sources. This data can be analyzed and transformed into useful information, then presented to personnel (e.g. Plant Manager's Workplace, Figure 27) to improve operations efficiency and profitability.

System 800xA Information Management features include:

- **Intuitive Information Presentation:** Desktop displays provide concise, enterprise-wide system and process information in a familiar office presentation format without requiring personnel to leave their office workplaces. A discrete tag ticker continuously shows business Key Performance Indicators (KPIs), providing fingertip, real-time, and historical information on planned versus actual production status. Tag ticker information can be supplemented with a trend display when more detailed information and status are required.
- **Automated System Actions:** Versatile scheduling options provide automatic triggers for key system actions such as process data collection, running calculations on process data, report generation, historical information archiving, and history data consolidation to provide a single, plant-wide history repository, as well as system back-up functions. Scheduled actions can be based on cyclic scheduling or can be event-driven, time based, or performed on demand, requiring minimal effort to perform repetitive system activities.
- **Flexible Report Generation and Distribution:** A variety of reporting software is supported including Microsoft® Excel and Crystal Report for very familiar, easy-to-use formats. Standard report templates are included, which offer quick report setup. These reports can fulfill plant and regulatory agency documentation requirements as well as provide powerful tools for decision-making and planning for improved operations performance.
- **Secure Historical Data Storage and Access:** Fault tolerant and distributed data configurations provide dependable data and information availability. The information is also protected by user access restrictions and offline storage. Users can be confident that electronic record keeping requirements are being met and that their decisions are based upon reliable information.

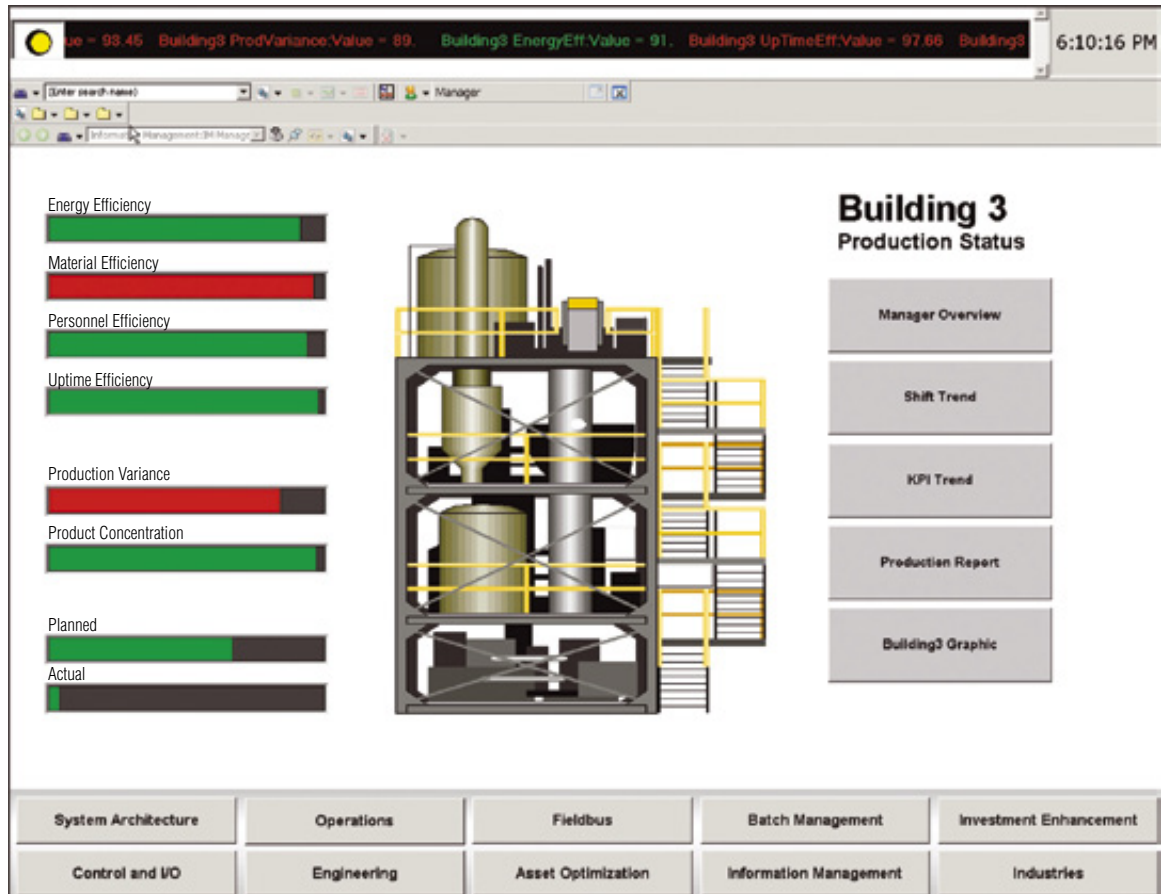

Figure 27. Manager's Desktop Information Workplace

Information Management is integrated with Harmony, ensuring that all process data and events are securely collected, stored, and archived. Plant users are then able to access, analyze, report, and document all Harmony data to improve plant operations.

For more details, please refer to the System 800xA Information Management Overview, 3BUS092079.

cpmPlus Smart Client for Harmony

Smart Client provides Harmony users with a browser-based thin client for displaying information from System 800xA (Figure 28). The cpmPlus Smart Client is a true thin client that seamlessly retrieves data from ABB's System 800xA and connected third-party systems. Displays are available inside and outside the plant facility, as long as a connection to the plant exists (i.e. VPN). The cpmPlus Smart Client utilizes the extended automation capabilities of the System 800xA technology to provide intelligent data access and viewing functions to assist all levels of personnel in making quick, informed decisions and taking the appropriate action, thereby improving performance.

Major benefits of the cpmPlus Smart Client include:

- Eliminate duplicate engineering by using the existing data definitions. All information defined in System 800xA, including upper and lower limits, is seamlessly available inside cpmPlus Smart Client.

- Simplified display configuration requires no programming. Displays configured using drag-and-drop display components and information from System 800xA property browser.
- No additional costs based on tag count. Information from all connected System 800xA's is available.

These benefits allow companies to lower their overall cost of ownership and to leverage the advantages of ABB's System 800xA extended automation environment.

The feature set of the cpmPlus Smart Client includes:

- Thin client based graphical displays
- Trending and statistical process control
- Alarm and Event Reporting
- Microsoft Excel Interface

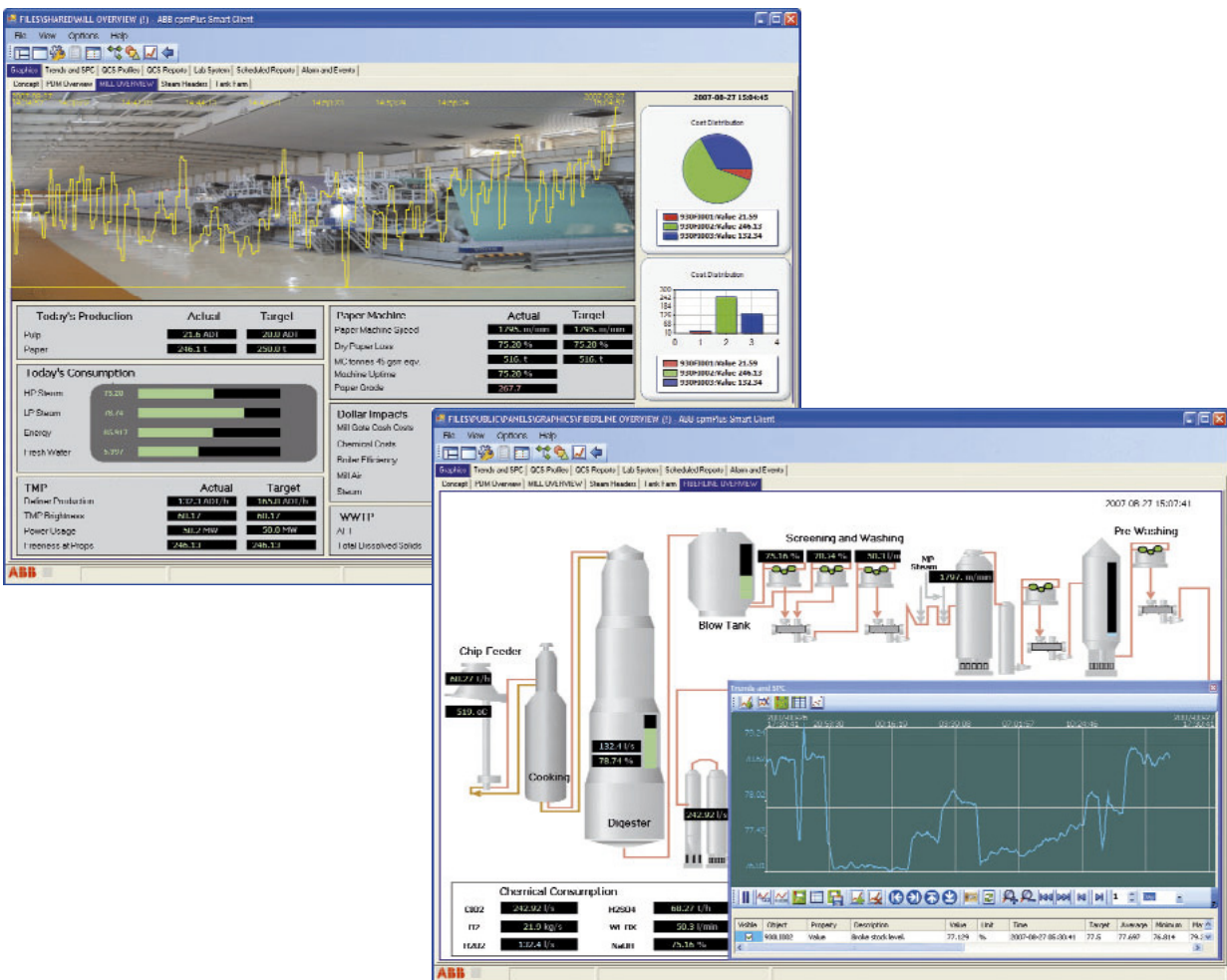

Figure 28. Using Smart Client, information from System 800xA for Harmony or connected third-party data sources is readily available on users' PCs and can be easily customized to allow access to the precise data needed to make better decisions

For more details, please refer to the cpmPlus Smart Client brochure, 3BTG6000PM1002.

Lowering System Lifecycle Costs and Risk through System Evolution

As stated earlier, ABB has a long-standing commitment to its system owners that ensures future advances in system technologies will enhance rather than compromise their current system investments. For over 25 years, ABB's evolution policies have allowed system owners to maximize the useful life of both their control systems and the intellectual assets built upon them. Through stepwise their system evolution solutions, the risk associated with system change is mitigated; minimizing process/system down-time and protecting the owner's long-term investments in control applications, process graphics, and historical data.

Working side-by-side with Harmony system owners and guided by the owner's business goals, ABB assists in the development of the evolution path and its pace. Regardless of whether the initial investment was made 1, 5, 10, or 15 years ago, the installed automation system is still a vital and sustainable part of the business and manufacturing strategy that can be enhanced and extended for years to come in a way that presents the lowest lifecycle costs and lowest risk.

Four-Point Evolution Strategy

Superior products are the cornerstone of ABB's evolution strategy; however, simply incorporating new products into an existing system will not ensure success or provide the desired results. ABB's evolution commitment consists of a four-point strategy that represents a comprehensive solution and provides a roadmap to successful system evolution. This four-point strategy includes:

1. Product Planning Process

ABB's system planning and development strategy is fundamental - new features and capabilities must be adapted seamlessly with minimum impact to existing applications. The development process involves rigid guidelines to ensure the compatibility of differing versions and models of system components. Each new step is a natural progression of the current system offering and never behaves like a plug-in or raw adaptation of someone else's product. For example, the application code runs as it did when first developed and new controllers seamlessly coexist on the same control network as previous generation controllers.

In order to fulfill an individually tailored upgrade path, ABB system enhancements provide a unique blend of flexibility and scalability. The ability to mix and match hardware and software of different generations is a major strength. ABB has services and solutions that preserve the system owner's investments. This ensures the continued use of base control hardware infrastructure and protects the intellectual asset investment made in software applications. For example:

- **Process Graphics:** Save time and expense of re-engineering and intensive user/operator retraining
- **Database:** History data preservation restores existing historical data and can be transferred directly to the new history platform
- **Field Wiring:** Eliminates the need for field re-wiring and reduces the time and costs of re-testing when existing I/O is replaced with a new I/O product
- **Control applications:** Preservation of field proven control configurations and documentation minimizes production risk and project / engineering costs

2. Customer Evolution Planning Process

A successful evolution program begins with a solid plan driven by the owner's business goals. Good planning is critical for any incremental, stepwise evolution and can minimize the negative production impact of the actual upgrade process. It can simplify and improve the yearly budgeting process and facilitate better system upgrades and planned plant shutdowns.

Individualized planning is essential. Different industries invariably have different strategies and business issues going forward. At ABB, account managers and technical experts work with system owners individually to address their unique needs. The collaborative relationship results in the best strategies for each individual site.

After a comprehensive audit of the existing system, and with an understanding of the business drivers, ABB will:

- Submit a 3-5 year plan to be reviewed and revised as necessary. ABB's incremental approach supports flexibility; allowing for changes to the plan as required over time.
- Identify and target which facilities are at the greatest risk for production loss and those that have the greatest potential for increased production. As each phase is identified, ABB will provide value assessments and Return-on-Investment support for consideration in order to facilitate successful project appropriation requests.
- Review the long-term plan periodically; update as required to reflect changing business needs and new ABB solutions. This approach takes the guessing out of the budgeting process. As part of this planning process, specific projects are identified and implemented.

3. Customer Evolution Programs

ABB promotes a proactive approach to hardware and software upgrades; working with system owners to stay current and avoid hitting the brick wall of obsolescence through stepwise, incremental upgrades. This philosophy allows system owners to continuously improve productivity as new technologies and automation product offerings become available.

ABB evolution programs provide the financial flexibility to move from existing automation system products to new, higher performance human system interfaces, system engineering tools, controllers, control networks, and information management – one functional area at a time.

ABB's **Automation Sentinel** software management program assists system owners in actively managing their lifecycle costs in ABB control system software. With this program, they can keep control software up-to-date and maintain a flexible path forward to new system software technology. Automation Sentinel helps manage software assets with timely delivery of the latest software releases, thus providing subscribers:

- Better productivity through enhanced software functionality
- Lower support cost and simpler software management through known annual subscription fees
- A way to stay current with the latest industry / IT standards
- Access to the most current system documentation
- Evolution to higher levels of human system interface, control, information management, and connectivity

Automation Sentinel program deliverables are summarized below in Table 6.











	Licenses for new versions of installed software products
	Software maintenance updates
	Software licenses for evolution to equivalent functions in newer technology products, including System 800xA
	Extended support for System 800xA software version... up to seven years
	Technical phone support to assist with system software updates
	On-line website access for downloads: <ul style="list-style-type: none"> • Software updates • Firmware updates • User manuals • Release notes • Product bulletins
	Software security management: <ul style="list-style-type: none"> • Microsoft security patch validation status • Third party virus scanner qualification
	System 800xA computer hardware qualification on replacement pc models is available
	Device Library management updates for 800xA systems: <ul style="list-style-type: none"> • PROFIBUS • FOUNDATION Fieldbus • HART
	Auto notification by email: <ul style="list-style-type: none"> • Technical updates • Product release information

Table 6. Automation Sentinel deliverables



4. Solutions Delivery

Delivery of sound system solutions based on evolution plans is another important process in the evolution value chain. ABB’s system engineers are highly trained, skilled, and equipped with the tools and resources to do the job right. These ABB resources know what is installed, know what is needed to meet future goals, and have the know how to deliver it.

The project begins with a comprehensive review of the requirements formulated in the long-term plan. ABB engineers work closely with the system owner to formulate a project plan and that achieves the desired end results. Based on this collaborative effort, the engineers design a solution that delivers results, protects system investments, and presents the lowest risk possible during installation.

Summary

With today's economic restraints putting pressure on capital spending, ABB system owners need to perform smarter and better at substantial cost savings. The business challenge they face is to squeeze the most productivity from their installed system through new functions and features, to extend its useful life and the applications within it, and to reduce maintenance costs while improving overall reliability.

ABB delivers the extended automation scope that enables system owners to be successful in today's highly competitive business markets by evolving their existing Symphony Harmony system with Industrial IT Extended Automation – System 800xA's best-in-class productivity enhancement software.

Learn more about evolution of Symphony Harmony systems to System 800xA Extended Automation at www.abb.com/controlsystems.



ABB AB
Open Control Systems
Västerås, Sweden
Phone: +46 (0) 21 32 50 00
Fax: +46 (0) 21 13 78 45
E-Mail: processautomation@se.abb.com
www.abb.com/controlsystems

ABB Industry Pte Ltd
Open Control Systems
Singapore
Phone: +65 6776 5711
Fax: +65 6778 0222
E-Mail: processautomation@sg.abb.com
www.abb.com/controlsystems

ABB Inc.
Open Control Systems
Wickliffe, Ohio, USA
Phone: +1 440 585 8500
Fax: +1 440 585 8756
E-Mail: industrialitsolutions@us.abb.com
www.abb.com/controlsystems

ABB Automation GmbH
Open Control Systems
Mannheim, Germany
Phone: +49 1805 26 67 76
Fax: +49 1805 77 63 29
E-Mail: marketing.control-products@de.abb.com
www.abb.de/controlsystems